

SECOND ADDITIONAL PROTOCOL TO THE
AGREEMENT
ON THE MULTINATIONAL PEACE FORCE
SOUTH - EASTERN EUROPE

The States-Parties to the Agreement on the Multinational Peace Force South-Eastern Europe, signed in Skopje on the 26th of September 1998, as supplemented and amended by the First Additional Protocol thereto, signed in Athens on the 12th of January 1999.

Reaffirming their commitment to the aims and principles provided for in the aforementioned two international documents,

Desiring to further develop the cooperation among them and to strengthen their emergency relief and humanitarian intervention capabilities,

Willing to establish the necessary provisions and amendments to the aforementioned Agreement, have agreed on the following:

ARTICLE 1

The Parties hereby establish an Engineer Task Force (ETF) in accordance with the provisions of the following articles.

ARTICLE 2

1. Further to the existing organization and responsibilities of the SEEBRIG, an ETF, composed of the units provided by the Parties on a case by case basis and depicted on the Annex A', attached to this Protocol, shall be formed and, subject to the provisions of article 5 of this Protocol, shall be under the command and control of SEEBRIG.

2. The scope of the formation of the ETF is to provide the Parties with an emergency relief and humanitarian intervention capabilities.

3. This initiative shall be oriented towards small-scale civil assistance in the interest of the Parties.

ARTICLE 3

1. ETF shall provide immediate support to local population on a stand alone basis or in conjunction with appropriate international bodies.

2. ETF shall conduct, subject to national decisions, small cooperation projects in the field of:

- a. Limited road construction and repair
- b. Limited bridging and bridge repair
- c. Limited rail repair
- d. Earth moving
- e. Drainage
- f. Limited de-mining, Unexploded Ordnance clearance
- g. Any other agreed functional areas

ARTICLE 4

The contributing Parties shall make engineer units available to the ETF, depending on the missions and national decisions. The ETF shall be an «on-call» force.

ARTICLE 5

The following phases have been agreed in order to implement the above mentioned initiative:

1. Phase-I (Initial):

- a. Command and control to be performed by COMSEEBRIG.
- b. During non-crisis operations, two officers to ensure the necessary planning functions shall augment the existing SEEBRIG Engineer Cell (CG-7).
- c. During crisis operations, a Crisis Engineer Cell shall be established, headed by an engineer officer (OF-5) who shall be provided by the COMSEEBRIG's Country.
- d. Every Party, which participates in a crisis operation, shall provide one engineer officer to the Crisis Engineer Cell. Where possible, the Parties, which will participate in a crisis operation, shall transfer their representative from the Engineer Cell (CG-7) to the Crisis Engineer Cell.

2. Phase-II

Based upon experience gained during Phase I, the parties may consider the feasibility of an alternative ETF command and control arrangement under the Politico-Military Steering Committee (PMSC) of the Multinational Peace Force South-Eastern Europe (MFPSEE) in parallel with SEEBRIG.

ARTICLE 6

The Parties agree on the establishment of a CRISIS INFORMATION NETWORK (CIN), initially a PfP Information Management System (PIMS) based capability oriented toward support of the ETF. COMSEEBRIG and the Parties are invited to employ the CIN to the maximum extent feasible and practicable.

ARTICLE 7

1. In crisis situation, the Chairman of the PMSC, upon a proposal by any Party or on his own initiative, convokes the PMSC in order to discuss the situation and formulate proposals for ministerial approval, providing subsequent appropriate guidance to COMSEEBRIG.

2. The CIN is intended to serve as the primary information source and communication link between the PMSC, COMSEEBRIG and the Parties.

ARTICLE 8

1. Except as otherwise agreed by the Parties, only those Parties, which participate in the projects or crisis operations, shall be responsible for their funding. Moreover, the PMSC of the MPFSEE shall examine alternative sources of funding, such as the European Union, the World Bank or NATO.

2. The projects may be conducted as multilateral exercises.

ARTICLE 9

The Appendices 1, 2 and 3 of the Annex A' and the Appendices 2 and 4 (page 4-4) of the Annex C' of the above-mentioned Agreement are replaced by the Appendices attached to Annex B' to this Protocol.

ARTICLE 10

1. This Protocol constitutes an integral part of the Agreement on the Multinational Peace Force South-Eastern Europe, signed in Skopje on the 26th of September 1998, as supplemented and amended by the Additional Protocol thereto, signed in Athens on the 12th of January 1999.

2. This Protocol shall enter into the force after all Parties notify the depositary about the completion of their internal legal procedures.

Signed in Bucharest on the 30th of November 1999 in seven original copies in the English language.

On behalf of the States-Parties to the Agreement:

Mr. Ilir Bocka, Deputy Minister of Defence

Mr. Gueorgui Ananiev, Minister of Defence

Mr. Nikola Kljusev, Minister of Defence

Mr. Apostolos Tsohatzopoulos, Minister of National Defence

Mr. Carlo Scognamiglio, Minister of Defence

Mr. Victor Babiuc, Minister of National Defence

Mr. Sabahattin Cakmakoglu, Minister of Defence

ANNEX - A

NATIONAL CONTRIBUTIONS

Nation No.1 : One Engineer Company

Nation No.2 : One Engineer Company

Nation No.3 : One Engineer Company

Nation No.4 : One Engineer Framework (from one company to
regiment)

Nation No.5 : One Engineer Platoon

Nation No.6 : One Engineer Company

Nation No.7 : One Engineer Construction Company



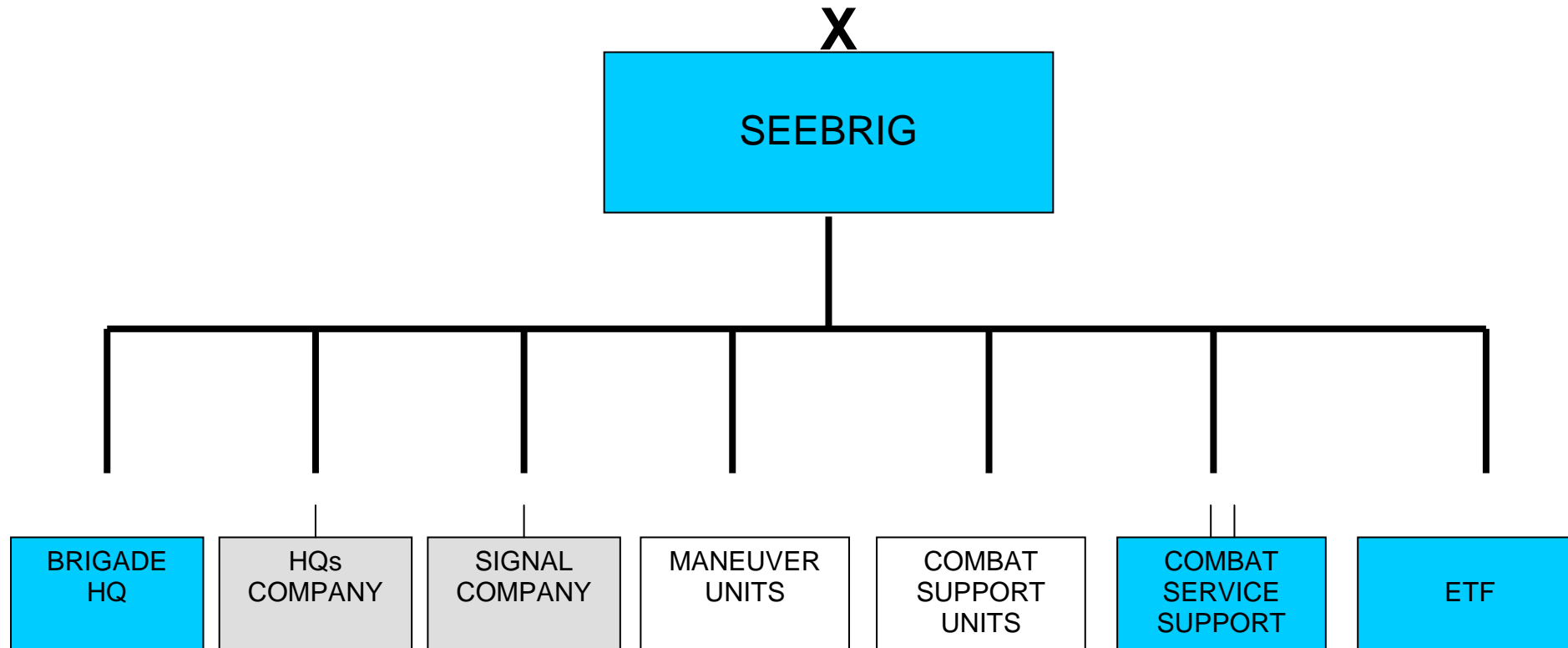











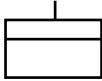
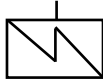
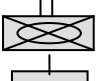







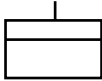
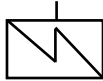
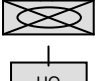



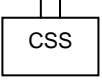



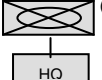

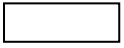







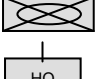







SEEBRIG GENERAL STRUCTURE

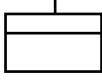
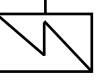
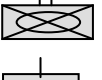

 MULTINATIONAL

 HOST NATION
(HQs LOCATION)

NATIONAL TROOPS CONTRIBUTIONS

NR.	NATION	BDE HQ	SIGNAL COY	MANEUVER UNITS	COMBAT SUPPORT UNITS	COMBAT SERVICE SUPPORT BATTALION	ETF	
1								
2				 HO	 	CSS (-)   		
3				 HO	  	CSS (-)  HQ  		
4				 HO (-) MAINTENANCE PLT SIGNAL PLT MEDICAL PLT ENGINEER PLT	 	DEPENDING ON CONTINGENCY 	 (*)	
5								
6				 HO - RECCE PLT - MORTAR PLT - SIGNAL PLT - LAUNCH PLT	 	  	 OR 	
7				 HO - SUPPLY AND MAINTENANCE PLT - SIGNAL PLT - MEDICAL PLT - QUARTERMASTER PLT - RECCE PLT - MORTAR PLT	  	CSS (-)  HQ  	 CONSTRUCTION	

 IF BDE HQ IS LOCATED IN RESPECTIVE COUNTRY,
 REGARDLESS OF LOCATION OF BDE

1 INF COY
12 MECH INF COY

* From 1 company to regiment to framework

SEEBRIG

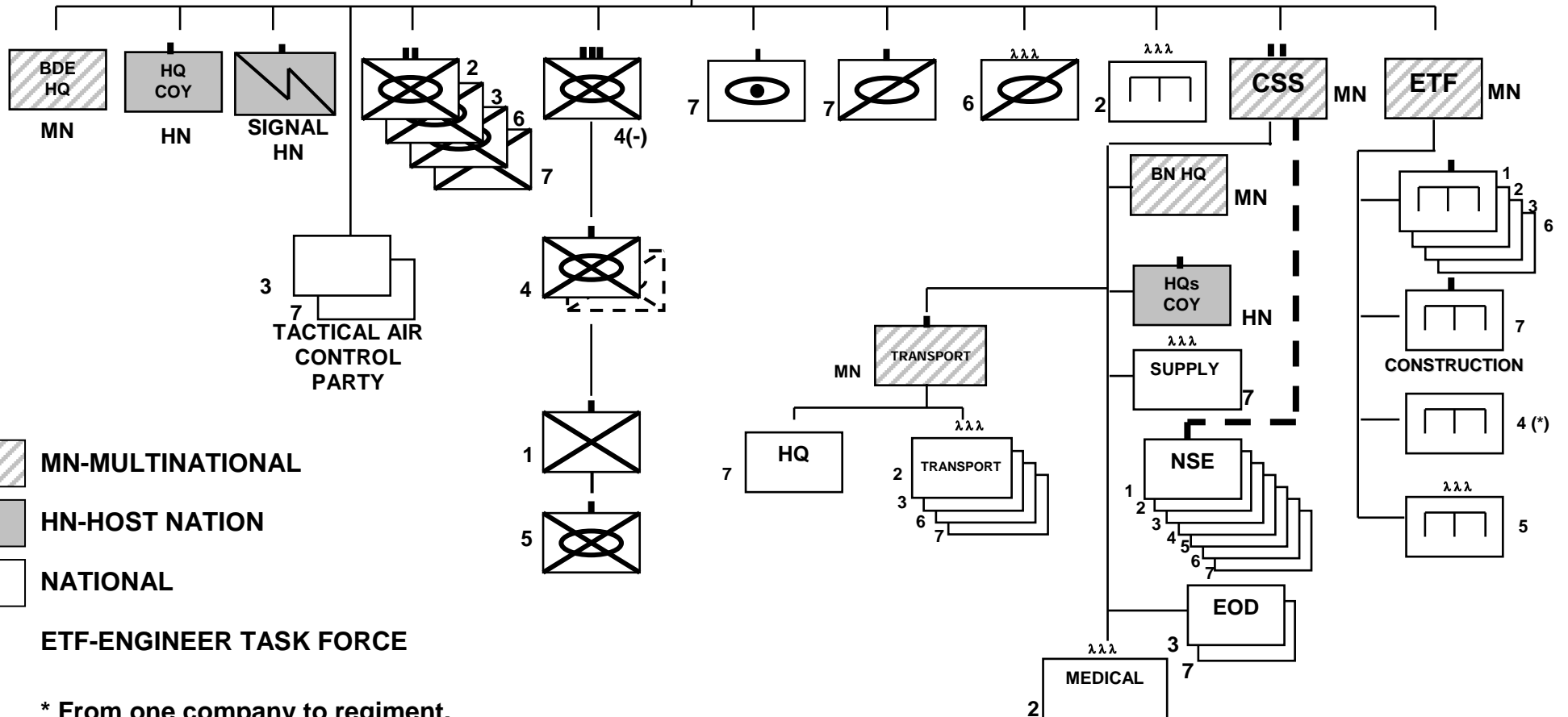

MN-MULTINATIONAL

HN-HOST NATION

NATIONAL

ETF-ENGINEER TASK FORCE

* From one company to regiment.

ANNEX - B

AMENDMENTS TO THE AGREEMENT ON MPFSEE

HQ SEEBRIG / NUCLEUS STAFF

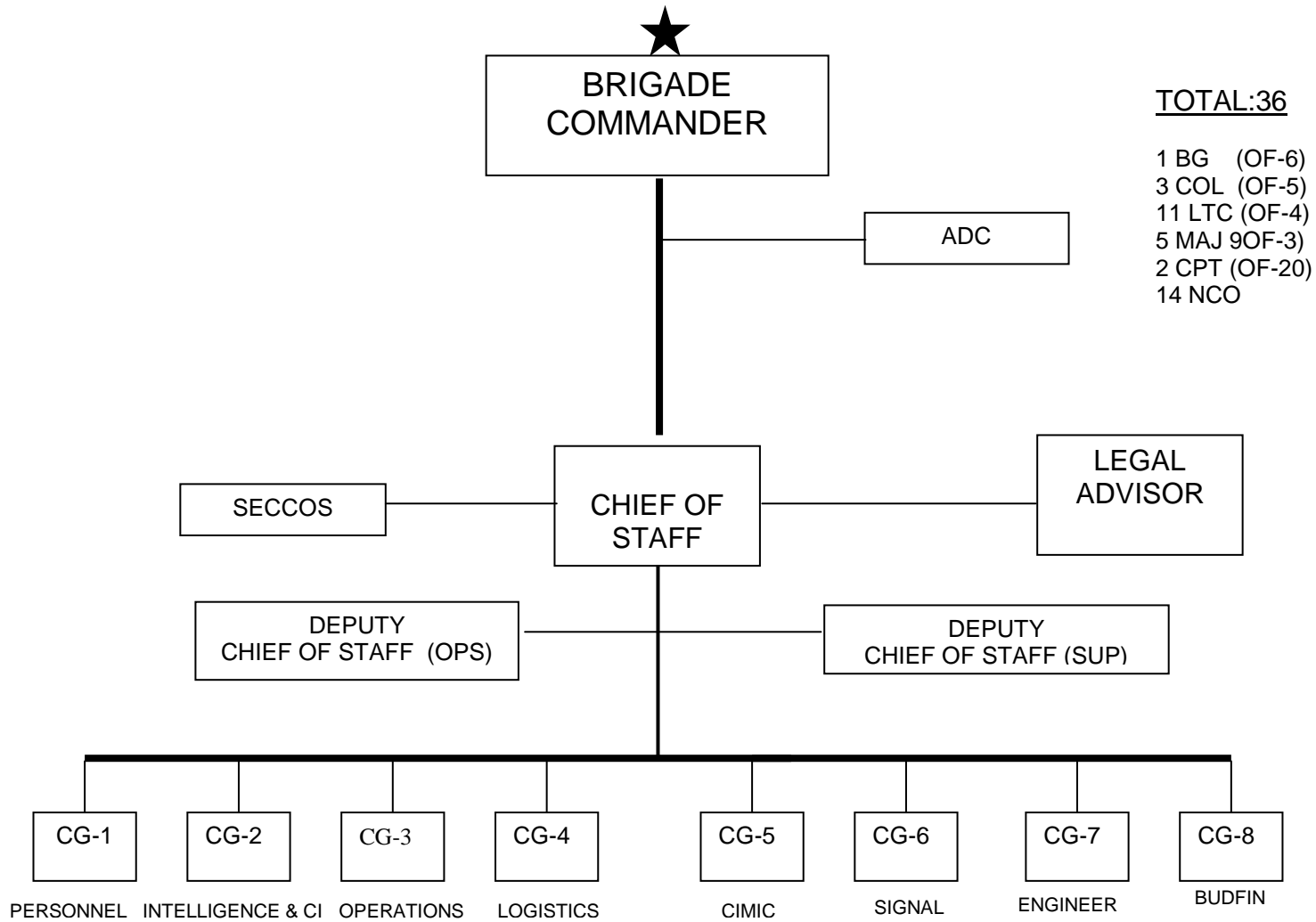

ANNEX C APPENDIX 4

OFFICE OF THE CHIEF CG-7 (ENGINEER)

CE NO	PE NO	JOB TITLE	RANK	SVC	SOURCE	REMARKS
CECG701	PECG701	CHIEF CG-7	OF-4	A	1/5	ENG PLANS OFF
CECG703	PECG703	ENG OFF	OF-3	A	3	
CECG704	PECG704	ENG OFF	OF-2	A	TBD	
CECG706	PECG702	CLERK/DRIVER	OR-4	A	1/5	

OFFICE OF THE CHIEF CG-8 (BUDFIN)

CE NO	PE NO	JOB TITLE	RANK	SVC	SOURCE	REMARKS
CECG801	PECG801	CHIEF CG-8	OF-4	A	3	FUND MANAGER
CECG806	PECG802	CLERK/DRIVER	OR-4	A	3	

2

TOTAL: 36

- 1 BG (OF- 6) (REFER TO THE AGREED ROTATIONAL TABLE)
- 3 COL (OF-5) (REFER TO THE AGREED ROTATIONAL TABLE)
- 11 LTC (OF-4)
- 5 MAJ (OF-3)
- 2 CPT (OF-2)
- 14 NCO

- **NOTE 1:** REFER TO MULTINATIONAL PEACE FORCE SOUTHEASTERN EUROPE HQ LOCATION AND CRITICAL ROTATIONAL SLOTS TABLE FOR SOURCE OF THE SLOT
- **NOTE 2:** WHEN TURKEY IS HOST NATION, SECCOS WILL BE FILLED BY GREECE; AND CHIEF OF G-2 AND DRIVER SLOTS WILL BE FILLED BY TURKEY.
- **NOTE 3:** THIS SLOT WILL BE FILLED BY BULGARIA DURING THE FIRST FOUR YEARS; AFTER THE FIRST FOUR YEARS, THIS SLOT WILL BE PERMANENTLY FILLED BY ROMANIA.
- **NOTE 4:** THIS SLOT WILL BE FILLED BY ROMANIA DURING THE FIRST FOUR YEARS; AFTER THE FIRST FOUR YEARS, THIS SLOT WILL BE PERMANENTLY FILLED BY BULGARIA.